

TAF-150-60-8-10 -- Square Shaft 1-1/2" RCS Lead Section

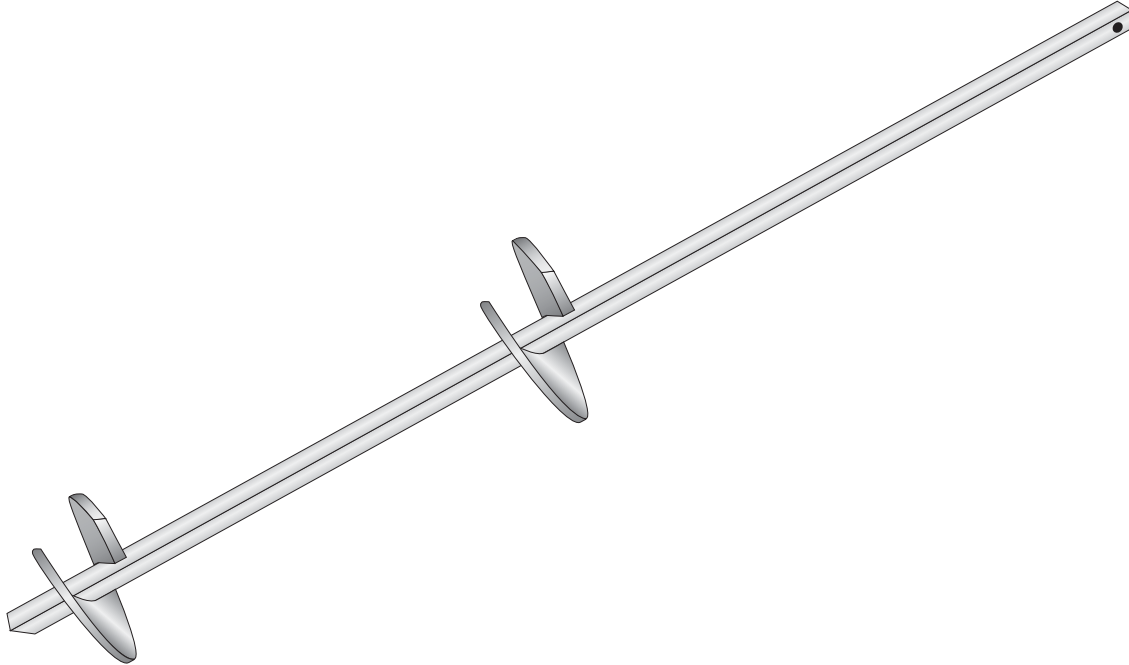

Product Specifications

Anchor Style	Square Shaft (150) Anchor
Component	Lead Section
Number of Helices	2
Helix Diameter	8" (203 mm) - 10" (254 mm)
Length	60" (1524 mm)
Flight Thickness	3/8" (9.5 mm)
Flight Yield Strength	50,000 lbs (222.4 kN)
Rod Tensile Strength	70,000 lbs (311.4 kN)
Torque Rating	7,000 Ft Lbs (9,492 N-M)
Coating	Hot-Dip Galvanized
Standard Package	25
Standard Package Unit	EA
Min Order Qty	1
Weight/Ea.	62 lbs
Weight Per Pallet	1550 lbs

Notes

Square Shaft (150) Lead Section, 60" Length (914 mm) long with 8" (203 mm) - 10" (254 mm) Helices